

A Framework for Inter-Domain Routing in Virtual Coordinate based Mobile Networks

Falko Dressler · Mario Gerla

Published online: 27 February 2013

Abstract Routing is considered to be one of the most challenging problems in MANETs. It has been shown that the use of virtual coordinates or identifiers for efficient routing and data management has several advantages compared to classical topology control techniques based on pre-defined addresses or geographical coordinates. However, these advantages only hold for single domain networks with limited mobility. In a previous paper, we discussed the challenges arising from using virtual coordinates for routing (to a particular destination ID or to indexed data or resources) in mobile networks in multi-domain network scenarios. We developed a solution by managing data with a Distributed Hash Table (DHT) scheme. Based on our Virtual Cord Protocol (VCP), we then implemented inter-domain routing using appropriate indirections. That approach, however, was still limited in finding efficient routes over multiple transit networks. In this paper, we extend that work by defining a framework for optimized inter-domain routing. In particular, we investigate the use of Ant Colony Optimization (ACO) for optimizing routes between multiple network domains. We show how distributed routing tables can be created and maintained

This paper, in which we primarily focus on the applicability of ACO for efficient inter-domain routing in MANETs, is an extended version of work presented at ICC 2010 and at BIO-NETICS 2010. Our work has been partially supported by the BaCaTec project “support for inter-domain routing and data replication in virtual coordinate based networks”.

F. Dressler
Computer and Communication Systems, Institute of Computer Science, University of Innsbruck, Austria
E-mail: falko.dressler@uibk.ac.at

M. Gerla
Network Research Lab, Dept. of Computer Science, University of California, Los Angeles, CA, USA
E-mail: gerla@cs.ucla.edu

and we outline a heuristic for finding candidate routes. Simulation experiments confirm the efficiency of the selected routes both on an intra and on an inter-domain level.

Keywords inter-domain routing · virtual cord protocol · ant colony optimization · mobile networks

1 Introduction

Several classes of different routing techniques have been investigated in the field of mobile ad hoc networks. The key objective is to cope with heterogeneity of nodes, dynamics of the environment, and, most importantly, the limited available energy resources [1], for example in the case of smart phones. Especially in the field of Mobile Ad Hoc Networks (MANETs), routing becomes difficult as nodes are assumed to be mobile. Meanwhile, the MANET community is no longer focusing on random movement strategies but on application dependent moves, for example, vehicles on roads or people moving in groups. Early approaches for routing in MANETs mainly focused on establishing routing tables by flooding the entire network (or parts of the network if operating using hierarchies or cluster building techniques). These routing tables either need to be updated continuously in so-called proactive approaches, or flooding is performed whenever a new route is needed in reactive solutions. However, it turned out that the inherent protocol overhead for topology control is not adequate in both variants to extend the network lifetime [11] for personal area networks. Therefore, stateless approaches have been investigated such as geo-routing, where the content is represented by geographic coordinates of the destination. In this case, all nodes have geographic position identifiers (learned for example from GPS). Such

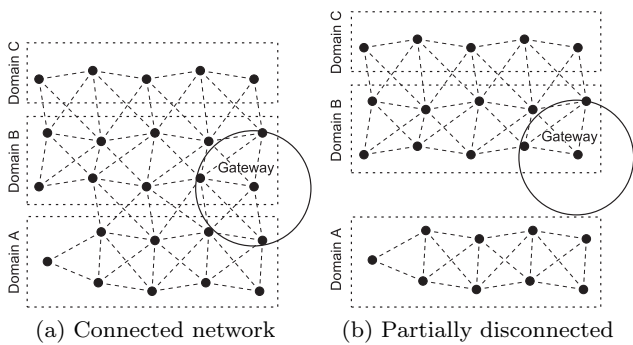

Fig. 1: Schematic representation of partially connected sensor network domains

position-based routing solutions inherently improve the situation as simple greedy routing towards the destination can be used. However, such approaches only work well if the network is dense, as routing holes may cause geographic routing to rely on inefficient face routing methods [23], that is, if greedy routing leads to a local optimum, this situation needs to be solved by slowly “walking around” the critical region. Recently, a number of improvements to overcome these geo-routing problems have been proposed. One idea is to “re-arrange” the nodes’ positions appropriately to prevent routing holes [20]. The main idea is to use either location transformation or additional virtual location identifiers.

A conceptually more innovative approach is to rely on virtual coordinates only and to create an overlay network that connects the nodes and guides the search. Protocols like Virtual Cord Protocol (VCP) [3, 5] and Virtual Ring Routing (VRR) [6] build their own *virtual coordinate system*, which is completely independent of the geographic node positions. Furthermore, the virtual node positions can be used as IDs in a Distributed Hash Table (DHT) to efficiently store and retrieve data. Current work on virtual coordinate based approaches focuses on two aspects: The provided quality of service, which is mainly an issue of optimizing the delivery ratio or even providing guarantees [25, 32], and the reliability of the system as a whole, using data replication and other redundancy increasing techniques [4]. Such solutions are inherently self-organizing and scale extremely well even for large-scale networks [13].

Many scenarios can be envisioned in which multiple (virtual coordinate based) networks have to be established and maintained separately, yet with a strong demand to support routing across these different networks in case they become connected. The problem is illustrated in Fig.1. Zones labeled A, B, and C represent three individual networks operated, for example, by virtual coordinate based protocols such as VCP.

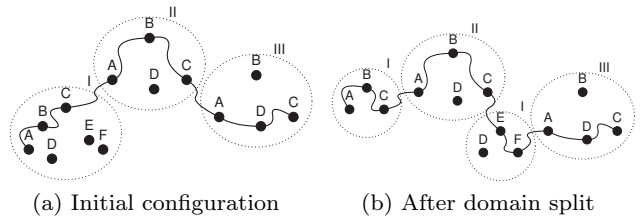

Fig. 2: Topology changes at domain level: domain I splits and gets re-located

Such protocols do not inherently support communication between multiple domains. Inter-domain routing is to be provided between the zones. As depicted in Fig. 1b, the connectivity between such domains might not be constantly available, for example, if domains move according to a group mobility model [36]. Thus, the selected gateway may spontaneously become disconnected. However, we assume that the network integrity (in terms of an ordered overlay) for a single domain is almost always ensured. Whenever two networks get into each other’s physical radio communication range, data can be exchanged between the domains. A key challenge is to provide inter-domain routing between different local networks because the virtual coordinates are usually managed locally in each domain.

Inter-domain routing in MANETs has been first discussed in [8].¹ Four challenging issues have been identified: addressing, membership management, handling domain-level topology changes, and routing between the networks. As Internet-based protocols have been considered, the addressing and membership management basically targeted the IP address assignment procedure and the resulting routing problems. A cluster-based solution for inter-domain routing in MANETs has been described in [35]. Here, especially the issue of domain-level topology changes has been addressed. Using Bloom filters, the effort for necessary topology updates was greatly reduced. Fig. 2 outlines some of the most typical problems. At a macroscopic level, domain management techniques must be developed taking care of splitting and merging domains, and of domain-wide topology changes. On a microscopic level, different nodes will have to provide gateway functionality as soon as physical connection is available. The inter-domain routing is responsible for establishing adequate paths.

Motivated by this work, we investigated in an earlier paper the issue of inter-domain routing for virtual coordinate based routing protocols, in particular focusing

¹ The term Inter-domain routing in MANETs has been coined in [8] and has frequently been used since. More correct would be Inter-MANET routing as there are no autonomous systems in the classical meaning of Internet BGP routing.

on our VCP approach [15,16]. We were able to show that inter-domain routing in virtual coordinate environments can be established exploiting available DHT-based data management operations. Inter-domain routing between neighboring domains becomes feasible with only marginal overhead. The key idea is to rely on the concept of indirections by establishing different virtual inter-domain routing entities. Basically, available gateway nodes between neighboring groups are stored in the local DHT. This allows to find at least one solution to transmit messages via an available gateway using an indirection via the DHT. Similarly, routing information between arbitrary groups is stored and updated in the local DHT. Yet, no optimized inter-domain routing was possible, that is, finding an almost optimal path instead of using just a path.

We further studied this inter-domain routing concept in virtual coordinate based networks using bio-inspired techniques [18]. In particular, we used a routing heuristic based on Ant Colony Optimization (ACO) [12] to optimize both the *macroscopic* and the *microscopic* behavior even in very dynamic environments. The development of such self-organizing algorithms strongly depends on an optimal calibration of the system parameter [14]. Thus, we first investigated the configuration of the ACO algorithm using empirical studies. Using these results, we performed a detailed performance analysis of the developed ACO heuristics based inter-domain routing scheme. The results clearly indicate that the developed algorithm is extremely stable and robust to topology changes.

In this paper, we extend our previous work by introducing a generalized routing framework for inter-domain routing that covers optimized routing between two domains and provides efficient path heuristics for a transit-domain scenario. The contributions of this paper can be summarized as follows:

- We discuss the problem of inter-domain routing in the field of mobile networks with a strong focus on virtual coordinate based routing and data management techniques.
- We present a generic inter-domain routing framework supporting virtual coordinate based routing protocols. We exemplarily discuss the integration with the Virtual Cord Protocol.
- We employ a technique known from bio-inspired networking, namely Ant Colony Optimization, to optimize the path selection in this environment. Our simulation results clearly indicate that the selected heuristic performs very well in typical scenarios.

2 Related Work

We briefly summarize related approaches for routing in mobile ad hoc networks, focusing on the most recent approaches relying on virtual coordinates in the intra-domain case.

Recently, a number of improvements to overcome geo-routing problems have been proposed. One idea is to “re-arrange” the nodes’ positions appropriately to prevent routing holes. A typical example of this strategy has been described in [20]. The main idea is to use either location transformation or additional virtual location identifiers. The second, more innovative concept is to rely on virtual coordinates only and to create an “overlay” that connects the nodes and guides the search so that it does not get stuck in a hole. One of the first works in this field was the Terminodes concept [22]. Virtual structures in hybrid routing have been explored in [2]. More recent protocols like VCP [5] and VRR [6] build their own coordinate system, which is completely independent of the geographic node positions.

Current work on virtual coordinate based solutions focuses on two aspects: The provided quality of service, which is mainly an issue of optimizing the delivery ratio or even providing guarantees [25,32], and the reliability of the system as a whole, using data replication and other redundancy increasing techniques [4]. Many of these approaches exploit the availability of the virtual ordering (numbering) of the nodes on an overlay that allows the use of DHT like operations for data management. Both VRR and VCP inherently integrate a DHT that is used for routing as well as for data storage and lookup. Similarly, the recently published Prefix Routing Over Set Elements (PROSE) approach is based on distributed hashing for scalable MANET routing [30]. The previous examples use an one dimensional overlay (e.g., a ring or cord). There are also examples of multi-dimensional overlays like CAN [28].

However, the use of virtual coordinates, which are usually managed locally in each domain in a way to optimize routing, data management, or both, makes inter-domain routing extremely complicated. We contribute in this field providing an indirection-based approach, explicitly using the available data structures in such virtual coordinate-based systems.

Inter-domain routing in mobile networks is still a rather new field. It quickly turned out that classical inter-domain routing approaches such as BGP [29] are not adequate in networks with highly dynamic topologies. Inter-domain routing in MANETs has been first discussed in [8]. Four challenging issues have been identified: addressing, membership management, handling domain-level topology changes, and routing between

the networks. As Internet-based protocols have been considered, the addressing and membership management basically targeted the IP address assignment procedure and the resulting routing problems. This concept has further been enhanced in recent work, still following the BGP principles [31].

A cluster-based solution for inter-domain routing in MANETs has been described in [35]. Here, especially the issue of domain-level topology changes has been addressed. Using bloom filters, the effort for necessary topology updates was greatly reduced. Most recently, this scheme has been further evaluated to improve the connectivity in the inter-domain scenario [26]. Based on the bloom filter approach, the reliability of the network connection has been investigated.

Basically, all this previous work is based on either probabilistic routing using the bloom filter approach or on full topology knowledge as a basic guideline how to transmit packets over transit domains. In contrast, we investigated the issue of inter-domain routing for virtual coordinate based routing protocols, in particular focusing on our VCP approach [15,16]. We were able to show that inter-domain routing in virtual coordinate environments can be established exploiting available DHT-based data management operations. Inter-domain routing between neighboring domains becomes feasible with only marginal overhead.

3 Basic Inter-Domain Routing using VCP

The Virtual Cord Protocol (VCP) has been developed for efficient routing and data management in sensor networks. In previous work, we demonstrated that VCP outperforms MANET-based solutions as well as other virtual coordinate-based protocols such as VRR [3, 5]. We continued this research by studying inter-domain routing between multiple VCP domains [15,16]. In the following, we briefly outline the concepts of VCP, before presenting our generalized inter-domain routing framework.

3.1 Virtual Cord Protocol

The main idea is to arrange all the nodes in the network in form of a virtual cord. The cord is defined as a possible way of interconnecting all the nodes in the network using a single thread. The topology of this cord must not be “optimal” in any sense, because routing is organized by exploiting information about the physical neighbors for greedy forwarding. Nevertheless, the cord ensures the availability of at least one path between any two nodes in the network for guaranteed delivery.

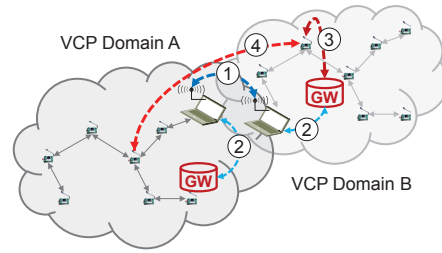

Fig. 3: Inter-domain routing using VCP

The cord is established using periodic HELLO messages. This is quite similar to the concept of beacon stuffing proposed for ad hoc wireless networks [7]. Besides the assigned virtual address, these messages carry all relevant information including the physical and the virtual neighbors. One node must be pre-programmed as the initial node, i.e. it gets the start position $S = 0$. Based on received HELLO messages (at least one is required) in the last time interval, a new node can determine its position in the cord. A cord is formed according to a number of simple rules. Basically, new nodes either join at one end of the cord, or get integrated, if at least two other nodes that are virtual neighbors in the cord are detected. A special rule is applied if the node has connectivity to a non-end node but not to its virtual neighbors. Then, a *virtual position* is generated at the discovered potential neighbor that is close to its virtual coordinate. This address allows the new to join between the real and the virtual position in the cord, i.e., to extend the cord without disrupting it. An application-dependent hash function is used for associating data items to nodes; thus, both pushing to a node and pulling data from a node are supported. The same mechanisms can also be used for service discovery.

3.2 Domain Concept

Conceptually, we associate each network with a unique domain identifier. This can be performed in VCP during the cord setup phase by assigning this ID to the start node. Currently, no specific duplicate detection has been integrated, but this can easily be added using the concepts provided for Duplicate Address Detection (DAD) as proposed in Mobile IPv6 or for address selection in sensor networks [17, 33]. Then, all nodes joining the cord also obtain the domain ID. The concept is depicted in Figure 3. The periodically exchanged HELLO messages also contain the domain ID (step 1 in Figure 3). If two networks are getting into each others communication range, a node receiving HELLO messages from another domain automatically becomes a gateway node. It then stores this information into the local DHT

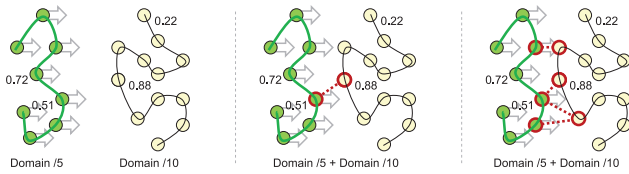

Fig. 4: VCP inter-domain routing example

Table 1: Sample routing table

| Gateway | Source domain | Destination domain |
|---------|---------------|--------------------|
| 0.27 | VCP /5 | VCP /10 |
| 0.51 | VCP /5 | VCP /10 |
| 0.90 | VCP /5 | VCP /10 |
| 0.88 | VCP /10 | VCP /5 |
| ... | | |

by hashing the well-known identifier of the gateway service and storing the information at the node closest to the resulting hash value (step 2). If the gateway no longer receives HELLO messages from the detected neighbor, it removes the gateway information from the DHT. This way, the local DHT always contains the most recent gateway information and routing between neighboring domains becomes possible using simple indirections. Whenever a node wants to transmit a packet to another domain, it pulls the gateway address from the DHT (step 3) and then forwards the message via the gateway node (step 4).

An example is depicted in Figure 4. Two VCP domains are becoming interconnected, first by a single gateway, at a later point in time, multiple gateway nodes become available. In the following, we use the notation `node id/domain id`, e.g. `0.22/10`, to identify nodes in a particular domain. Let's assume that node `0.72/5` needs to transmit a message to node `0.22/10`. It first looks up an appropriate gateway. The first available gateway in our example is `0.51/5`. Thus, `0.72/5` forwards the data to `0.51/5`, which, in turn, forwards it to the other domain, i.e. to gateway node `0.88/10`, to finally reach `0.22/10`. If more than a single gateway is available, any one can be used to reach the other domain. The routing tables are distributed (and replicated, if necessary) by means of the internal DHT. An excerpt of a typical routing table is shown in Table 1.

3.3 Basic Inter-Domain Routing

The HELLO messages are not only used for the identification of neighboring nodes or domains. This concept is the fundamental basis of the inter-domain routing framework. In particular, it is responsible for the au-

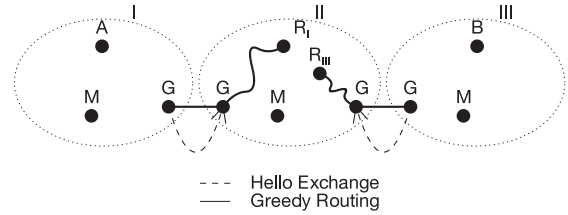

Fig. 5: Exchange and processing of HELLO messages

tonomous domain management. Two roles are dynamically assigned to nodes in the network: *Gateway* nodes are responsible for detecting neighboring domains, storing this information in the local DHT, and to provide forwarding capabilities to remote domains; and *Router* nodes represent a virtual function storing all available gateways to a particular domain. They basically provide all the inter-domain routing functionality using indirections as known from overlay networks.

The essential mechanisms for maintaining domain information and to assign gateway and router roles to nodes in the network is the HELLO mechanism of VCP. In the single domain case, VCP maintains its internal cord structure using such HELLOs in order to inform neighboring nodes about the presence of others that are part of the same virtual cord. We extended this mechanism to also distributed associated domain IDs. The basic procedure is depicted in Figure 5 (*G* and *R* denoting gateway and router nodes, respectively). This informs neighboring nodes not only about the presence of other domains but also allows to assign roles.

Gateway nodes – After receiving a HELLO message from another domain, i.e. the domain ID is different from the local domain ID, the receiving node immediately becomes a gateway to the other domain. Thus, gateway functionality is related to *physical* connectivity to a co-located domain. The gateway is now able to transmit data to the detected domain. NB: gateway functionality only allows unidirectional connectivity. Bidirectional communication is only possible if the corresponding node in the other domain also received a HELLO from its counterpart. As we assume that the domains are mobile, this information needs to be continuously updated. Thus, each gateway is assigned only for a limited period of time (typically, two of three times the HELLO interval). If the information is not refreshed in this time period, the node drops gateway functions.

Router nodes – In order to support routing between two connected domains (i.e., at least one gateway node has been assigned), the information about available gateways needs to be made available to all nodes in the network. Flooding of this information to all nodes would allow to set up shortest paths towards respective gate-

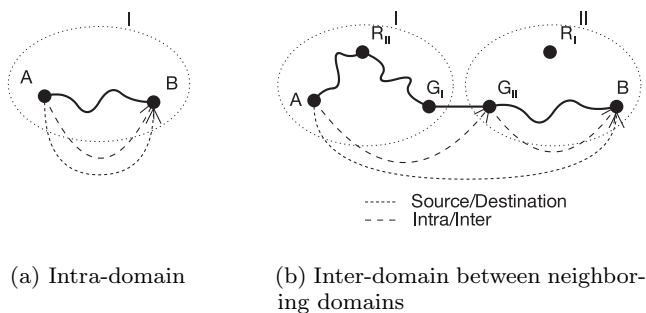

Fig. 6: VCP routing within a domain and between neighboring domains

ways but this concept does not scale for high mobility scenarios, i.e. if gateway nodes frequently become available and become dis-assigned again. Therefore, we use the concept of indirections as typically used in overlay networks. The router node is responsible for maintaining a complete routing table to a specific neighboring domain. This is a *virtual* function allocated to a node using a hash function that takes the domain ID of the remote domain as input. Thus, for each domain, a separate virtual router node will be created. The information maintained at the router node is depicted in Table 1. Basically, it provides a list of all available gateways to this domain.

Because router nodes are virtual entities, depending on the size of the network and the used hash function, multiple routers might become co-located at a single physical node. We assume that the router functionality only requires limited resources of this node (for maintaining the routing table and to redirect messages transmitted to other networks, cf. Section 4.2).

VCP’s greedy routing is only used within a domain (Figure 6a). Inter-domain routing is supported using indirections to the respective router nodes [15]. Figure 6b outlines such a scenario. An indirection to the router node is used together with source routing on domain level. However, no transit domains are supported yet.

Direct communication between two nodes in arbitrary domains requires global topology information, i.e. the gateway information needs to be distributed into all VCP domains. Inter-domain routing can be supported using a shortest path algorithm together with source routing on domain level. VCP’s greedy routing is only used within a domain. We show a fully self-organizing way to obtain adequate routes based on path heuristics in the following section.

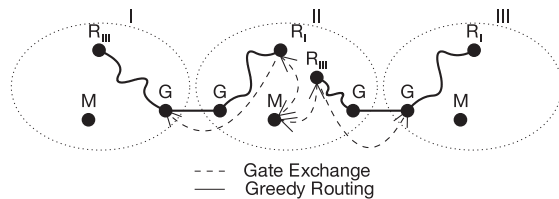

Fig. 7: Routing of `EXCHANGE_DOMAIN_SET` messages

4 Extended Inter-Domain Routing Framework

In the following, we outline our extended inter-domain routing framework. Essentially, additional routing information is needed to identify transit domains. In order to cope with the high dynamics of the network topology, adequate heuristics are needed because classical shortest path algorithms are unlikely to converge.

4.1 Extended Domain Management

In order to develop a generalized inter-domain routing framework for VCP, we had to define an additional role, which needs to be executed in each domain: *Moderator* nodes maintain, update, and exchange domain tables with moderators in remote domains. Thus, moderator nodes are responsible for creating all the relevant domain-level topology information.

Figure 7 depicts the setup of routing information. After detecting neighboring domains using the `HELLO` mechanism, the gateway node forwards this information to a local router node responsible for the detected domain, i.e., the virtual entity storing information for the associated hash entry. If the local routing table changes, this information is further forwarded to the moderator node, and, via the basic VCP inter-domain routing also to moderators in the neighboring domains. As such, this procedure is quite similar to classical BGP routing [29], even though indirections are necessary to access remote moderator nodes.

Moderator nodes – Summarizing the role of moderator nodes, which, similarly to router nodes, are virtual entities responsible for maintaining specific routing tables, it can be said that those moderators are the core of collecting network-wide domain information. Basically, a moderator (each VCP domain maintains exactly one moderator) stores and updates information about all known domains in the network. Reliable operation of a moderator (and a router) can be provided using VCP’s internal replication techniques.

The necessary message exchange depicted in Figure 7 is further detailed in Table 2. At time t_0 , each of the three domains is fully separated from each other,

Table 2: Exchange of domain information (cf. Figure 7)

| | Domain I | Domain II | Domain III |
|-------|--------------------------------------|---|--------------------------------------|
| t_0 | I | II | III |
| | HELLO(I) | HELLO(II) | HELLO(III) |
| | I, II | I,II,III | II, III |
| t_1 | HELLO(I) | HELLO(II) EX(I,III) \rightarrow I EX(I,III) \rightarrow III | HELLO(III) |
| | I, II, III | I,II,III | I, II, III |
| t_2 | HELLO(I) EX(III) \rightarrow II | HELLO(II) | HELLO(III) EX(I) \rightarrow II |

i.e., no HELLO exchange has occurred already. After a first HELLO exchange, all the domains learned about their direct neighbors. In particular, the gateway nodes involved in this HELLO exchange stored this information at the local virtual router nodes. Thus, at time t_1 , domain I learned about domain II and so on.

According to the extended inter-domain routing approach, the router nodes report changes to the moderator nodes, which, learn about the presence of new domain IDs. In turn, the interval's next information exchange does not only include HELLO messages but also messages informing neighboring domain's moderators about the refreshed list of known domains.

In special EXCHANGE_DOMAIN_SET messages, the moderator at domain II distributes knowledge about domains I and III to its neighboring domains' moderators (denoted as EX(domain set) \rightarrow domain in Table 2). After a final exchange at time t_2 , the network converges. The next information update (besides the periodic HELLO messages) will happen only after routing tables changed due to nodes' mobility.

4.2 Inter-Domain Routing Issues

Based on the established routing information, messages can be routed within a domain using the standard VCP greedy routing techniques and between neighboring domains relying on the indirection via the router node, and now, even between arbitrary domains exploiting the knowledge provided by the moderator nodes. Figure 8 outlines the message forwarding over a transit domain. In the source domain, a router node (R_{III}) has been created by the moderator. Thus, a message towards domain III is first routed to R_{III} . The indirection points towards an adequate transit domain (here, domain II), to which the message is forwarded using an appropriate gateway node. From within domain II,

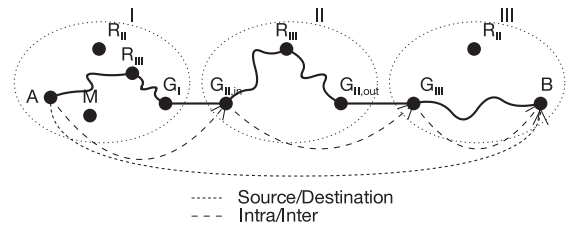

Fig. 8: Inter-domain routing between arbitrary domains

the message is forwarded as described for inter-domain routing between neighboring domains. Yet, no temporal changes of the domain-level topology are considered that might lead to fluctuations in the inter-domain connectivity.

Organizing inter-domain routing between arbitrary domains in an optimized way has a high complexity: First, the routing tables, i.e., the inter-domain network topology needs to be updated and maintained in order to ensure stable topology information and loop-free routes. This requires an extremely high amount of network traffic for topology control if dynamics and mobile nodes are considered. Secondly, the complexity of the routing tables and the paths that need to be calculated might be too high for mobile nodes. Therefore, classical routing algorithms cannot be used, even on domain level.

In order to transmit messages to foreign domains, the following two problems need to be solved as illustrated in Figure 9:

- First, inter-domain routing needs to be organized, i.e., the path between source and destination domains. This represents a *macroscopic* view to the routing problem. For example, as shown in Figure 9a, two possible routes exist between domains I and VII, with a branch at domain II.
- Secondly, the *microscopic* level need to be solved, i.e., which particular gateway node should be used for routing between two connected domains. This problem is outlined in Figure 9b.

Furthermore, the handling of indirections needs to be solved. Basically, two orthogonal approaches can be envisioned. Nodes may first query path information from moderator and / or router nodes before sending messages directly on the selected route. Alternatively, messages could be directly forwarded to the moderator and router nodes for relaying the messages towards their destination.

Both concepts are depicted in Table 3. Here, S and D represent the source and destination node, respectively, R and G are router and gateway nodes, and the exponent specifies the current domain (T meaning tran-

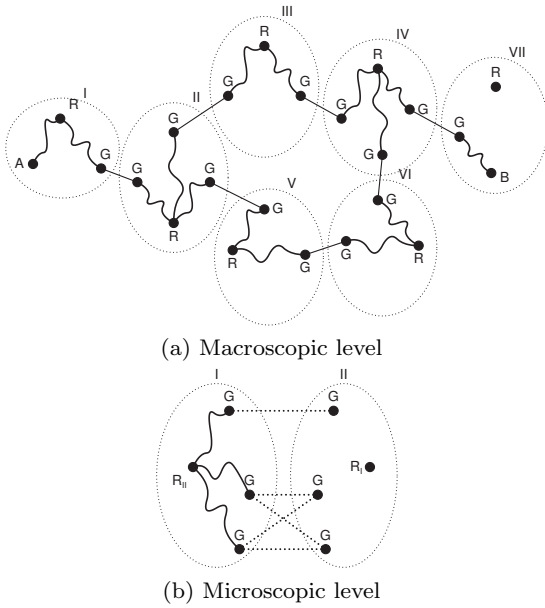

Fig. 9: Routing problems at macroscopic (domain) and microscopic (gateway) level associated with inter-domain routing

sit). Basically, the path between the source node and the gateway in the destination domain can be organized as follows:

- *Direct relay* – Indirections are applied directly by relaying packets. Thus, the source node S forwards the packet to router R^D without knowledge about the entire path. The packet is then relayed from R^D to the selected gateway node in the local domain, forwarded through the transit domain until it reaches the destination node D . If, at any stage, a path is not known, e.g. because a domain moved out of transmission range, an error message is generated and forwarded to the source node.
- *Route lookup* – Here, indirections are queried to establish a path (per domain) to the destination. After identifying the best gateway G_{out} , the message is sent directly from S to G_{out} . The same procedure is applied in each transit domain.

We finally decided to use direct relaying. In early experiments, it turned out that this indirection for all data packets does not lead to significant overhead for low and medium traffic load. In high load scenarios, it certainly makes sense to first querying the best path and then sending the packets directly. The indirection case also provides better performance in scenarios with rapid topology changes, because the router and moderator nodes will be informed first about such changes and can instantly rely on this updated routing information.

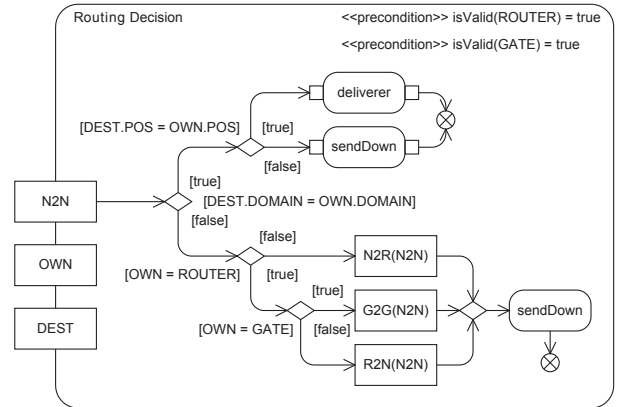

Fig. 10: Routing decision process

The internal routing decision process is outlined in Figure 10. All decisions will be applied at the node that currently handles the packet. In this figure, “sendDown” means normal intra-domain VCP routing, i.e. the transmission to the next hop on the inter-domain routing path. In a first step, the node identifies whether the packet already reached the destination domain. If this is the case, normal VCP routing takes over to deliver the packet. If not, the node analyzes if this is a node-to-router (N2R) packet, a gateway-to-gateway (G2G) packet, or a router-to-node (R2N) packet. The node then processes the associated routing tables and forwards the packet to the next hop, again using intra-domain VCP rules.

4.3 ACO-based Routing Heuristic

We propose a routing heuristic based on ACO that is able to cope with these two problems while ensuring a high degree of robustness to topology changes. Also, the selected solution is rather accurate, i.e., selected routes are close the theoretical shortest path. In the following, we outline the ACO based routing heuristic. Simulation results are discussed in Section 5.

Ant Colony Optimization (ACO) is a biologically inspired technique simulating the foraging process of social insects [12,19]. ACO uses a graph $G(N, E)$, N denoting the nodes and E undirected edges, respectively. Two nodes $i, j \in N$ are neighbors if $(i, j) \in E$. Each edge E_{ij} is annotated with some cost. A path is a sequence of nodes and edges between a source and a destination node. The objective of ACO is to find a path between source and destination with minimal costs.

ACO uses to called explorer ants, i.e., discovery packets, to explore the network. These packets need to be generated periodically to find possible routes to a given destination. In our system, we use such discovery pack-

Table 3: Possibilities for message forwarding using indirections

| Forwarding mode | Source domain | Transit domain | Destination domain |
|-----------------|--|---|--------------------------|
| direct relay | $S \rightarrow R^D \rightarrow G_{out} \rightarrow G_{in}^T$ | $G_{in}^T \rightarrow R^D \rightarrow G_{out}^T \rightarrow G_{in}^D$ | $G_{in}^D \rightarrow D$ |
| route lookup | $S \rightarrow R^S \rightarrow S$ | $G_{in}^T \rightarrow R^D \rightarrow G_{in}^T$ | $G_{in}^D \rightarrow D$ |
| | $S \rightarrow G_{out}^S \rightarrow G_{in}^T$ | $G_{in}^T \rightarrow G_{out}^T \rightarrow G_{in}^D$ | |

ets to find paths towards the other domains. In particular, we periodically send such discovery packets as soon as the system learns about new domains until they disappear again (timeout).

During initialization, each edge $(i, j) \in E$ in the graph G is associated with some initial pheromone level (weight) τ_{ij} :

$$\tau_{ij} \leftarrow \tau_0, \forall (ij) \in E \quad (1)$$

A complete iteration of the ACO algorithm consists of three steps:

1. Stepwise probabilistic solution

Setting up a path is based on stepwise estimation for each edge (i, j) according to Equation 2. Here, \mathcal{N}_i^k depicts the neighborhood of the k -th ant at node i , i.e., the k -th discovery packet.

$$p_{ij}^k = \begin{cases} \frac{\tau_{ij}^\alpha}{\sum_{l \in \mathcal{N}_i^k} \tau_{il}^\alpha} & j \in \mathcal{N}_i^k \\ 0 & j \notin \mathcal{N}_i^k \end{cases} \quad (2)$$

2. Deterministic pheromone update

After finding a solution, the ant returns. On this path, loops are eliminated by checking whether a path includes the same node twice. Furthermore, the returning ant updates the pheromone level for all edges (i, j) on the path. The new pheromone concentration is calculated according to Equation 3 where $\Delta\tau$ represents some positive value that indicates success in path finding. In our system, we used a small positive number according to the findings in recent ACO research.

$$\tau_{ij} \leftarrow \tau_{ij} + \Delta\tau^k \quad (3)$$

3. Pheromone evaporation

In order to make the algorithm robust even in case of high dynamics in the topology, the pheromone needs to be evaporated over time for all the edges. Basically, the pheromone level is decremented over time by some value $\rho \in (0, 1]$ as shown in Equation 4.

$$\tau_{ij} \leftarrow (1 - \rho) \cdot \tau_{ij}, \forall (ij) \in E \quad (4)$$

The algorithm converges if a solution reaches some certain quality level or if no more changes are performed.

ACO has already been successfully applied to several problems in networking. Most importantly, early approaches to routing need to be named such as the AntNet [9] proposal. Here, ACO has been used to set up probabilistic routing tables for standard Internet routing. This work has been directly used in the AntHocNet [10] algorithm, which has been designed for use in MANET environments, thus, in very dynamic networks with rapidly changing network topologies. It turned out that ACO was perfectly able to handle these dynamics.

Hierarchical solutions relying on a combination of ACO and table-driven routing on a higher layer have been investigated, e.g., in the HopNet approach [34]. In this paper, we use a similar scheme but using ACO on the higher (domain) level. As a further step, even combined routing and task allocation in mobile sensor networks has been investigated [24]. In this work, not only routing in mobile networks has been considered but also the distribution of multiple tasks to sensor nodes generating network traffic with different profiles (bursty, constant but high traffic volume, etc.). Obviously, ACO seems to be a perfect candidate for handling dynamics in the network topology with low overhead.

4.4 Optimized Inter-Domain Routing

In order to apply ACO to the problem of inter-domain routing in virtual coordinate based networks, we need to construct a graph, define a solution for the pheromone update, and find appropriate parameters for this update. We interpret the entire network as graph G and each VCP domain as a node $k \in G$. For each available gateway between two domains, we draw an edge $(i, j) \in E$ connecting the domains i and j . Thus, different to the classical ACO, we allow multiple edges between nodes. All the required information is already available in the inter-domain version of VCP as outlined in Sections 3.2 and 4. The resulting algorithm follows the ACO principles:

1. Set up a probabilistic route, estimate resulting costs;
2. Prune routing loops, update the costs for each gateway such that the probability to chose the best gateway reflects the estimated costs;

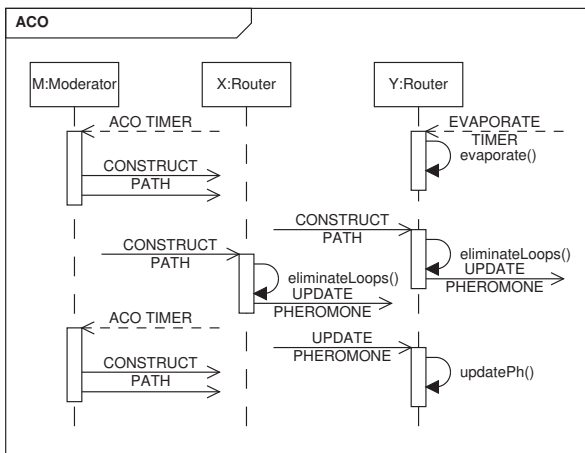

Fig. 11: Estimation of ACO-based routing heuristics

3. Update the costs while the algorithm is running to incorporate dynamic topology changes.

ACO is thus used to weight the used gateways in order to find a shortest (cost minimal) path between two domains. In the scope of this paper, we use the hop count as a routing metric to derive the costs for each gateway. Topology control and minimal cost routing is performed using artificial ants transmitted between the VCP routing domains. This technique is very robust to changes in the network topology. Domains that become connected to the network can be quickly integrated using such explorer ants. Removing a domain because no more gateways are available leads to a short period of inconsistent routing (which is typical for ACO-based heuristics). However, as the costs decrease quickly, this has no influence on active parts of the network.

Figure 11 shows a sequence diagram outlining the stepwise creation of a solution as well as the update of the costs for the gateway nodes. After receiving the `ACO_TIMER` signal, the moderator of a domain initiates the setup of paths to each reachable domain. Thus, it sends `CONSTRUCT_PATH` to the router nodes responsible for the respective destination domains. In order to cope with the dynamic topology at domain level, the `CONSTRUCT_PATH` messages can limit the maximum costs and the maximum number of hops.

When a message arrives at the destination router, the path is cleaned up and an `UPDATE_PHEROMONE` message is sent back to the destination using source routing along the stored nodes (i.e., exactly the same way back to the originating node). The pheromone value τ_G represents the cost of each gateway entry in the routing table. After receiving an `UPDATE_PHEROMONE`, the cost value of the gateway is updated according to Equation 5. The initial cost value is a small value τ_0 , K represents the

Table 4: Simulation parameters

| Input parameter | Value |
|----------------------|---|
| Number of Nodes | 10+10, 25+25, 100+100, 40 |
| Speed | fixed, 1 m s^{-1} , 3 m s^{-1} , 6 m s^{-1} |
| Query period | 1 s^{-1} |
| Initialization time | 100 s |
| mac.bitrate | 2 Mbit s^{-1} |
| mac.broadcastBackoff | 31 slots |
| mac.maxQueueSize | 14 packets |
| mac.rtsCts | false |

path costs.

$$\tau_G \leftarrow \tau_G + \Delta\tau, \text{ with } \Delta\tau = \frac{C}{1 + K}, C = \text{const} \quad (5)$$

The use of path costs in the pheromone update has some nice properties [12]: The quality of a solution is increased, a good solution can already be found using only a few explorer ants, and the quality of the solution becomes almost independent of the parameter α in Equation 2. Thus, the cost of a gateway in the routing table is directly proportional to the length of the entire path to the destination domain.

The evaporation process runs in parallel with the cost update. The parameter ρ influences the speed and quality of the routing convergence. For $\rho = 0$, no convergence is to be expected and for large ρ , the algorithm quickly converges to suboptimal solutions. Furthermore, the degree of mobility needs to be considered for identifying an optimal value for ρ .

We analyzed all the ACO parameters using some initial simulations. More details on the simulation framework and the used parameters are discussed in [18]. Based on these experiment, we identified optimal values for t_{ACO} , depicting the time between the periodic evaluations of the routing table, the evaporation factor ρ , describing the evaporation speed, the delay between two evaporations $t_{Evaporate}$, and the impact of $\Delta\tau$.

5 Simulation Results

We investigated the feasibility and the performance of the inter-domain routing concept for VCP in several simulation scenarios. We used our implementation of VCP for the simulation tool OMNeT++ to analyze the behavior of the dynamic gateway configuration and the performance of the inter-domain routing using indirect directions. Relevant simulation parameters are summarized in Table 4. We simulated VCP over IEEE 802.11b.

The simulation setup for the first set of experiments is depicted in Figure 12a. We placed two groups of nodes on the playground, one being stationary, the other

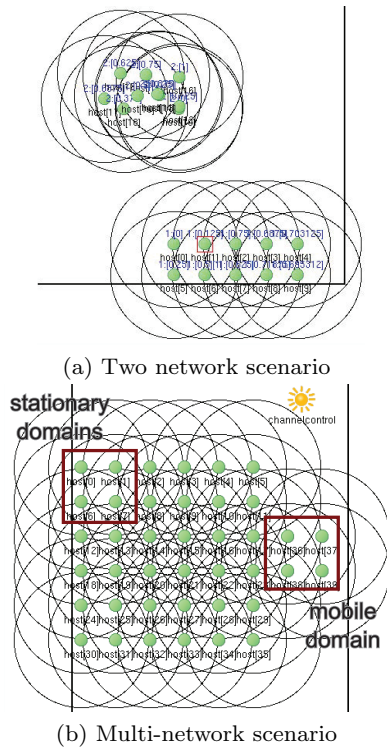

Fig. 12: Simulation setup

one being mobile. During the experiment, the group of mobile nodes approached the stationary nodes and departed again. In a second set of experiments, we created a setup including 10 VCP domains of 4 nodes each, 9 being stationary arranged in form of a rectangle (nodes have a partially overlapping radio range), and one network domain being mobile, moving along the perimeter, close to the border of the rectangle. Thus, the inter-domain routing framework had to keep track with a rather high degree of system dynamics, i.e. topology changes on domain level due to mobility. This setup is outlined in Figure 12b.

5.1 Two-Network Scenario

In the first set of experiments, which we prepared as a baseline for validation and comparison to previous results obtained for basic inter-domain routing between neighboring domains [15], we evaluated the performance of our enhanced inter-domain routing algorithm in a two-network scenario. We allow an initial setup time of 100s to establish two VCP networks, one for each group. Within this time, a node in the mobile network creates and inserts data items in this VCP domain. After the initialization, the mobile group moves towards the stationary group. After some time, the first nodes get into the radio range of the other group and they start to set

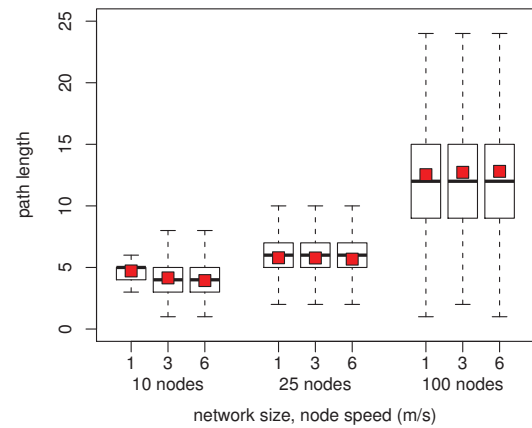

Fig. 13: Path length distribution for various network sizes and node speeds

up gateway information, and to exchange data packets. The simulation time has been chosen such that for the slow 1 m s^{-1} scenario the mobile domain completely passes the stationary domain. At higher speeds, multiple of such connections occur. In the second scenario, we used network 100 instead of 10 nodes in both networks to evaluate the impact of a larger number of gateway nodes and longer communication paths.

The metrics discussed in the following are shown as boxplots. For each data set, a box is drawn from the first quartile to the third quartile, and the median is marked with a thick line. Additional whiskers extend from the edges of the box towards the minimum and maximum of the data set. Data points outside the range of box and whiskers are considered outliers and drawn separately. Furthermore, the mean is plotted as a small red box.

We evaluated different measures such as the available gateways, the success rate, communication delays, and the path length distribution. All the results clearly show the feasibility of ACO to quickly find adequate routes in this simple setup. Exemplary, we show the path length between source and destination nodes located in opposite domains. Figure 13 shows the simulation results for different network sizes (we selected speeds of 1 m s^{-1} , 3 m s^{-1} , and 6 m s^{-1} according to the experimental setup in [35]). As can be seen, the network size has significant influence on the path length. This effect has been expected as the path length within each domain certainly increases. More interestingly, the speed has almost no influence as all the statistical measures (median, quartiles) are in a similar range. Very high speeds above 6 m s^{-1} lead to instabilities of the paths. Concepts like Last Encounter Routing (LER) might help to overcome this problem [21].

We also evaluated the success rate (Figure 14a) and the query delay (Figure 14b). As can be seen, the node

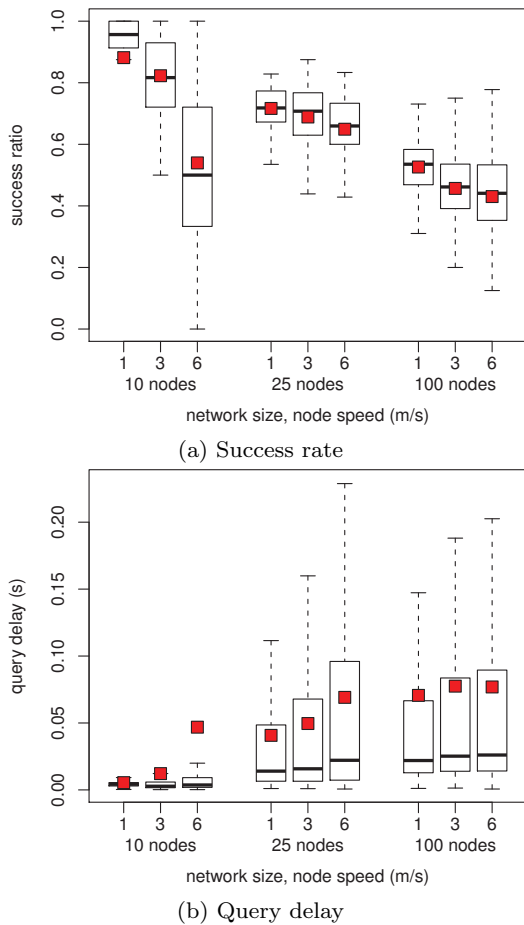

Fig. 14: Success rate and query delay for various network sizes and node speeds

speed has a much higher influence on smaller networks. This is due to the few available gateway nodes. If this number increases, i.e. more possible paths between the neighboring domains can be used, the success rate and the query delay are much more stable with increasing node speed. The other effect shown in Figure 14 is that both the success rate and the query delay degrade with increasing network sizes. The reason is, again, the much longer paths to be taken between source and destination. There is certainly a higher loss probability for higher hop counts and the delay adds up on the path.

Overall, the results look very promising as the inter-domain routing provides stable and efficient paths.

5.2 Multi-Network Scenario

In a second set of experiments, we evaluated the capabilities of the extended inter-domain routing framework for inter-domain routing including transit domains. We used the setup of 10 VCP domains described before.

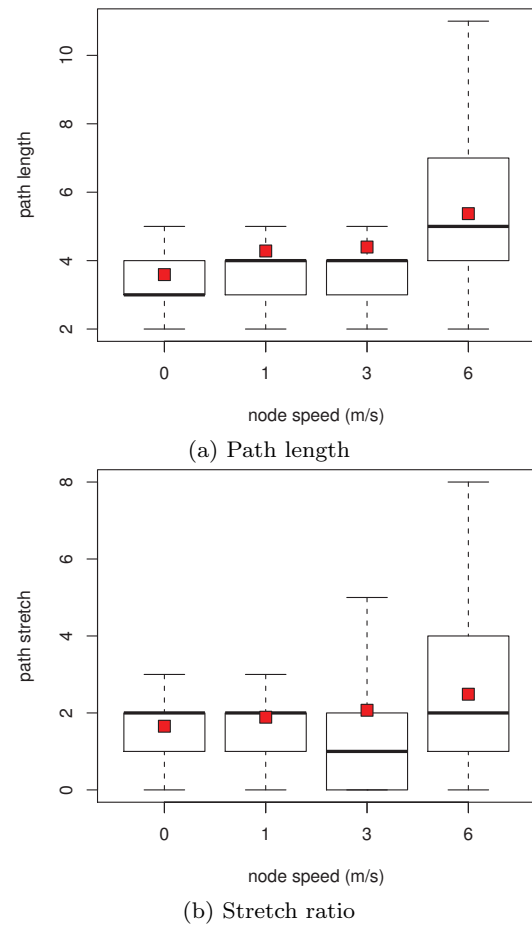

Fig. 15: Path length distribution and stretch ratio for different node speeds

This setup causes many topology changes on domain level and therefore allows to assess the quality of the used ACO based path heuristics.

As can be seen in Figure 15a, the discovered paths have been quite stable even though the network topology continuously changed on domain level. ACO very quickly reacted on these changes and enforced the use of alternate paths. The path lengths for the 6 m s⁻¹ scenario are longer on an absolute scale and show a higher variance. This can be expected as the available paths very rapidly break and alternate paths need to be used.

Measuring the overhead involved is not that simple. Simply counting the protocol messages is certainly not sufficient. Please note that periodic HELLO messages are used for cord maintenance as well as for assessing connectivity to other domains. The best way to measure the overhead is to look at the path lengths in comparison to the shortest path.

Figure 15b shows the path stretch, i.e. the distance of discovered paths from the theoretical shortest path. On average, roughly a factor of two has to be considered,

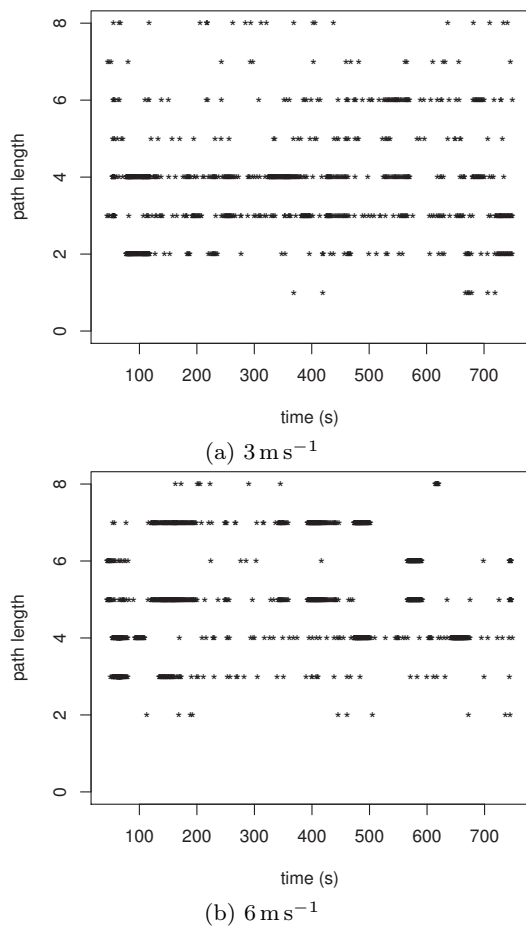

Fig. 16: Path length distribution for selected node speeds

which is extremely promising for fully self-organizing routing protocols in highly dynamic environments. The stretch shows a higher variance with increasing mobility. At 6 m s^{-1} , the average is at about 3.

Figures 16a and 16b show further details on the path length distribution for different speeds of the mobile domain. These two time series plots clear show that our extended inter-domain routing framework supports stable paths over longer periods of time. This can be seen in form of established plateaus in both graphs. Obviously, the length of those plateaus becomes shorter for higher node speeds.

We finally evaluated the query delay for the multi-network scenario. As shown in Figure 17, the transmission delay increases with increasing dynamics, i.e. higher speeds of the mobile network domain. This effect was expected as the ACO algorithm needs some time to reinforce the use of alternate paths by updating the associated pheromone level. The setup for 6 m s^{-1} shows reduced delays, which is due to the scenario setting. The initial upload of data items frequently failed.

Therefore, only a limited set of items could have been transmitted during the experiment.

6 Conclusion and Further Challenging Issues

We presented a framework for inter-domain routing in virtual coordinate based mobile networks. Our framework is based on concepts developed in the scope of the Virtual Cord Protocol. This can, however, be applied to any similar protocol such as VRR and even geographic solutions that support the use of (virtual) coordinates together with a hash function based storage and retrieval of information from nodes in the network. The main focus of this paper was on establishing a generalized routing framework that is able to maintain information about inter-connected domains. In particular, the framework provides a microscopic view on gateways directly connecting neighboring domains and a macroscopic view on the high-level domain topology. Using the concept of indirections, routes can be established between arbitrary nodes in any domain. For optimized inter-domain routing, we used a bio-inspired routing heuristic, the Ant Colony Optimization approach. The ACO-based routing heuristic provides means for routing well suited even in networks with significant dynamics, i.e. established and broken connections between multiple domains due to node movements. According to our simulation results, the protocol provides very stable routes between mobile groups of nodes.

Even though the presented solution is very promising, inter-domain routing in MANETs is still a challenging issue. As can be seen from the simulation results, with increasing dynamics in the topology, the quality of the established routing paths is reduced. Furthermore, there are situations in which no connectivity can be established. In these situations, other approaches might be used. Two possible research directions include story-carry-forward strategies as in Delay Tolerant Networks (DTNs) [27] and the explicit exploitation of mobility to set up a routing path as in encounter routing [21].

References

1. Akkaya, K., Younis, M.: A Survey of Routing Protocols in Wireless Sensor Networks. Elsevier Ad Hoc Networks **3**(3), 325–349 (2005)
2. Albin, L.C.P., Lima, M.N., Brawerman, A., Chessa, S., Maestrini, P.: Virtual Structure Effects in Two Hybrid Routing Protocols for Ad Hoc Networks. In: 3rd IEEE International Symposium on Wireless Pervasive Computing (ISWPC 2008), pp. 436–440. IEEE, Santorini, Greece (2008). DOI 10.1109/ISWPC.2008.4556245

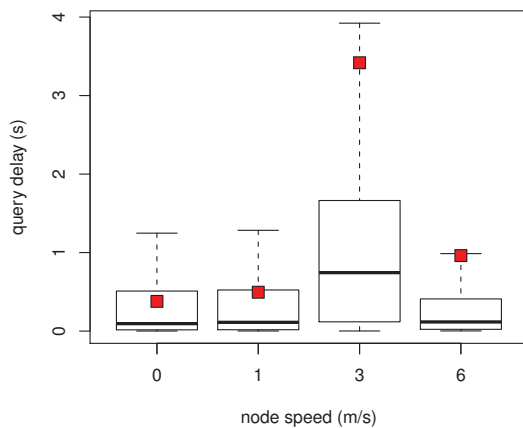

Fig. 17: Query delay

3. Awad, A., German, R., Dressler, F.: Exploiting Virtual Coordinates for Improved Routing Performance in Sensor Networks. *IEEE Transactions on Mobile Computing* **10**(9), 1214–1226 (2011)
4. Awad, A., Shi, L.R., German, R., Dressler, F.: Advantages of Virtual Addressing for Efficient and Failure Tolerant Routing in Sensor Networks. In: 6th IEEE/IFIP Conference on Wireless On demand Network Systems and Services (WONS 2009), pp. 111–118. IEEE, Snowbird, UT (2009)
5. Awad, A., Sommer, C., German, R., Dressler, F.: Virtual Cord Protocol (VCP): A Flexible DHT-like Routing Service for Sensor Networks. In: 5th IEEE International Conference on Mobile Ad-hoc and Sensor Systems (MASS 2008), pp. 133–142. IEEE, Atlanta, GA (2008)
6. Caesar, M., Castro, M., Nightingale, E.B., O’Shea, G., Rowstron, A.: Virtual Ring Routing: Network routing inspired by DHTs. In: ACM SIGCOMM 2006. ACM, Pisa, Italy (2006)
7. Chandra, R., Padhye, J., Ravindranath, L., Wolman, A.: Beacon-Stuffing: Wi-Fi without Associations. In: 8th IEEE Workshop on Mobile Computing Systems and Applications (HotMobile 2007), pp. 53–57 (2007). DOI 10.1109/HotMobile.2007.16
8. Chau, C.K., Crowcroft, J., Lee, K.W., Wong, S.H.Y.: Inter-Domain Routing Protocol for Mobile Ad Hoc Networks. In: ACM SIGCOMM 2008, 3rd ACM International Workshop on Mobility in the Evolving Internet Architecture (ACM MobiArch 2008), pp. 61–66. ACM, Seattle, WA (2008)
9. Di Caro, G., Dorigo, M.: AntNet: Distributed Stigmergic Control for Communication Networks. *Journal of Artificial Intelligence Research* **9**, 317–365 (1998)
10. Di Caro, G., Ducatelle, F., Gambardella, L.M.: AntHocNet: An adaptive nature-inspired algorithm for routing in mobile ad hoc networks. *European Transactions on Telecommunications, Special Issue on Self-organization in Mobile Networking* **16**, 443–455 (2005)
11. Dietrich, I., Dressler, F.: On the Lifetime of Wireless Sensor Networks. *ACM Transactions on Sensor Networks (TOSN)* **5**(1), 1–39 (2009)
12. Dorigo, M., Stützle, T.: *Ant Colony Optimization*. MIT Press/Bradford Books, Cambridge, MA (2004)
13. Dressler, F.: *Self-Organization in Sensor and Actor Networks*. John Wiley & Sons (2007)
14. Dressler, F., Akan, O.B.: A Survey on Bio-inspired Networking. *Elsevier Computer Networks* **54**(6), 881–900 (2010)
15. Dressler, F., Awad, A., Gerla, M.: Inter-Domain Routing and Data Replication in Virtual Coordinate Based Networks. In: IEEE International Conference on Communications (ICC 2010). IEEE, Cape Town, South Africa (2010)
16. Dressler, F., Awad, A., German, R., Gerla, M.: Enabling Inter-Domain Routing in Virtual Coordinate Based Ad Hoc and Sensor Networks. In: 15th ACM International Conference on Mobile Computing and Networking (MobiCom 2009), Poster Session. ACM, Beijing, China (2009)
17. Dressler, F., Chen, F.: Dynamic Address Allocation for Self-organized Management and Control in Sensor Networks. *International Journal of Mobile Network Design and Innovation (IJMNDI)* **2**(2), 116–124 (2007)
18. Dressler, F., Koch, R., Gerla, M.: Path Heuristics using ACO for Inter-Domain Routing in Mobile Ad Hoc and Sensor Networks. In: 5th ACM/ICST International Conference on Bio-Inspired Models of Network, Information and Computing Systems (BIONETICS 2010). Springer, Boston, MA (2010)
19. Ducatelle, F., Di Caro, G.A., Gambardella, L.M.: Principles and applications of swarm intelligence for adaptive routing in telecommunications networks. *Swarm Intelligence* **4**(3), 173–198 (2010)
20. Flury, R., Pemmaraju, S.V., Wattenhofer, R.: Greedy Routing with Bounded Stretch. In: 28th IEEE Conference on Computer Communications (IEEE INFOCOM 2009). IEEE, Rio de Janeiro, Brazil (2009)
21. Grossglauser, M., Vetterli, M.: Locating mobile nodes with EASE: learning efficient routes from encounter histories alone. *IEEE/ACM Transactions on Networking* **14**(3), 457–469 (2006)
22. Hubaux, J.P., Le Boudec, J.Y., Giordano, S., Hamdi, M., Blazevic, L., Buttyán, L., Vojnovic, M.: Towards Mobile Ad-Hoc WANs: Terminodes. In: IEEE Wireless Communications and Networking Conference (WCNC 2000), pp. 1052–1059. IEEE, Chicago, IL (2000). DOI 10.1109/WCNC.2000.904773
23. Kim, Y.J., Govindan, R., Karp, B., Shenker, S.: Geographic Routing Made Practical. In: USENIX/ACM Symposium on Networked Systems Design and Implementation (NSDI 2005). USENIX, San Francisco, CA (2005)
24. Labella, T.H., Dressler, F.: A Bio-Inspired Architecture for Division of Labour in SANETs. In: F. Dressler, I. Carerras (eds.) *Advances in Biologically Inspired Information Systems - Models, Methods, and Tools, Studies in Computational Intelligence (SCI)*, vol. 69, pp. 209–228. Springer, Berlin, Heidelberg, New York (2007)
25. Lin, C.H., Liu, B.H., Yang, H.Y., Kao, C.Y., Tasi, M.J.: Virtual-Coordinate-Based Delivery-Guaranteed Routing Protocol in Wireless Sensor Networks with Unidirectional Links. In: 27th IEEE Conference on Computer Communications (IEEE INFOCOM 2008). IEEE, Phoenix, AZ (2008)
26. Lu, Y., Zhou, B., Ku, I., Gerla, M.: Connectivity Improvement for Inter-Domain Routing in MANETs. In: IEEE Military Communications Conference (MILCOM 2010), pp. 617–622. IEEE, San Jose, CA (2010)
27. Pitkänen, M.J., Ott, J.: Redundancy and distributed caching in mobile DTNs. In: 2nd ACM/IEEE International Workshop on Mobility in the Evolving Internet Architecture (MobiArch 2007). ACM, Kyoto, Japan (2007)

28. Ratnasamy, S., Francis, P., Handley, M., Karp, R., Shenker, S.: A Scalable Content-Addressable Network. In: ACM SIGCOMM 2001, pp. 161–172. ACM, San Diego, CA (2001)
29. Rekhter, Y., Li, T.: A Border Gateway Protocol 4 (BGP-4). RFC 1771 (1995)
30. Sampath, D., Garcia-Luna-Aceves, J.: PROSE: Scalable Routing in MANETs Using Prefix Labels and Distributed Hashing. In: 6th IEEE Communications Society Conference on Sensor and Ad Hoc Communications and Networks (IEEE SECON 2009), pp. 1–9. IEEE, Rome, Italy (2009)
31. Train, J., Bannister, J., Raghavendra, C.: Routing fountains: Leveraging wide-area broadcast to improve mobile inter-domain routing. In: IEEE Military Communications Conference (MILCOM 2011), pp. 842–848. Baltimore, MD (2011). DOI 10.1109/MILCOM.2011.6127782
32. Tsai, M.J., Wang, F.R., Yang, H.Y., Cheng, Y.P.: VirtualFace: An Algorithm to Guarantee Packet Delivery of Virtual-Coordinate-Based Routing Protocols in Wireless Sensor Networks. In: 28th IEEE Conference on Computer Communications (IEEE INFOCOM 2009). IEEE, Rio de Janeiro, Brazil (2009)
33. Vaidya, N.H.: Weak Duplicate Address Detection in Mobile Ad Hoc Networks. In: 3rd ACM international Symposium on Mobile Ad Hoc Networking and Computing (ACM Mobihoc 2002), pp. 206–216. Lausanne, Switzerland (2002)
34. Wang, J., Osagie, E., Thulasiraman, P., Thulasiram, R.K.: HOPNET: A Hybrid ant colony OPTimization routing algorithm for Mobile ad hoc NETWORK. Elsevier Ad Hoc Networks 7(4), 690–705 (2009)
35. Zhou, B., Cao, Z., Gerla, M.: Cluster-based Inter-domain Routing (CIDR) Protocol for MANETs. In: 6th IEEE/IFIP Conference on Wireless On demand Network Systems and Services (WONS 2009), pp. 19–26. IEEE, Snowbird, UT (2009)
36. Zhou, B., Xu, K., Gerla, M.: Group and Swarm Mobility Models for Ad Hoc Network Scenarios Using Virtual Tracks. In: IEEE Military Communications Conference (MILCOM 2004), pp. 289–294. IEEE, Monterey, CA (2004)